



# MODELS CD400 AND CD550 BACKPACK SPRAYER ILLUSTRATED PARTS MANUAL

## Congratulations!

You're the owner of a Jacto commercial duty backpack sprayer, engineered using the latest technology and manufactured with advanced materials to provide long-life durability while delivering unsurpassed spraying performance.

Jacto backpack sprayers are designed and warranted for use with agrochemical solutions. These are serious spraying machines, yet they're easy to operate and simple to maintain.

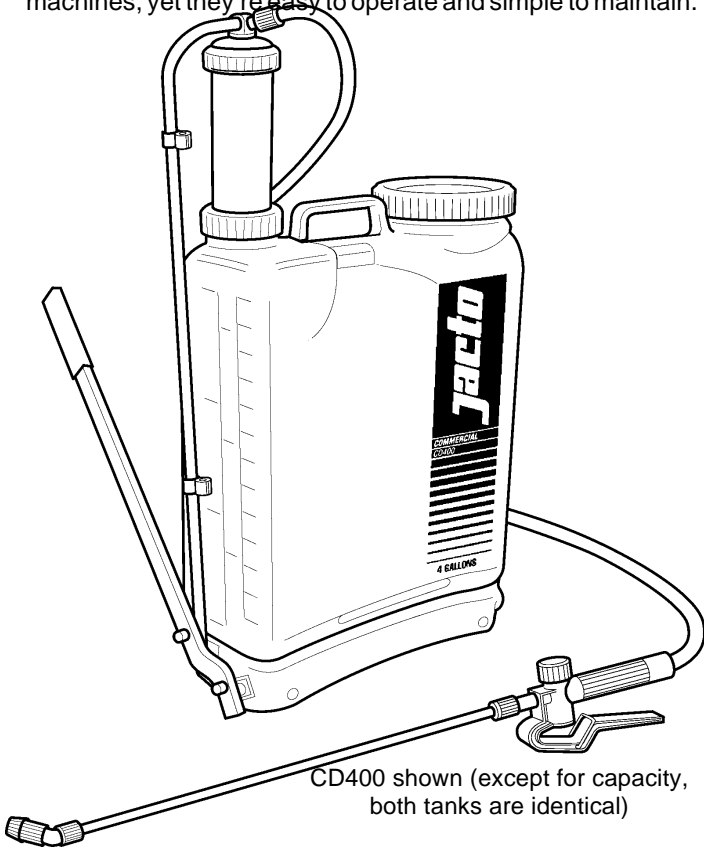

### Features Of Your New Jacto Sprayer

- High-efficiency, long-life brass piston pump for minimum operator effort
- Viton® seals are chemical resistant for longer life
- In-tank pump eliminates external pump leaks during or after operation
- Internal valve prevents over pressurizing pump chamber
- Easy-to-adjust padded shoulder straps for maximum comfort
- Reversible pump handle for right or left-hand operation
- Accurate filling scale is easy to read; measures liters and gallons
- Anatomical shape fits the operator's back for maximum comfort
- Extra-large tank fill opening for faster filling, reduced chance of spills
- Dry weight—  
CD400: 9.2 pounds,  
CD550: 10.6 pounds
- Easy maintenance and cleaning
- Convenient carrying handle built-in to tank top
- Spray wand storage clips standard equipment
- Operating pressure—  
15-65 psi
- UV resistant tank. Usable capacity—  
CD400: 4.0 gallons  
CD550: 5.5 gallons
- Flat bottom tank base resists tipping
- Steel tank base is powder coated to resist corrosion
- Internal mechanical agitator for constant mixing of tank solution
- Heavy-duty trigger valve is field serviceable
- Heavy Duty brass spray lance for maximum life
- Measuring cup, field service kit and 3 extra nozzles included at no extra charge
- One year limited warranty

## Limited Warranty

Jacto manufactures and distributes superior quality products to promote the highest customer satisfaction level possible. Jacto warrants these products to the original purchaser as follows:

### Warranty Period

One (1) year from the purchase date by the original owner.

### Warranty Application

Jacto warrants this product to be free from defects in materials and workmanship, under normal use and maintenance, subject to the periods, limitations, and exclusions listed below. Jacto will correct any defect in material or workmanship without charge for parts or labor at any authorized Jacto repair outlet during the covered warranty period.

To obtain warranty repair, present the defective product to your authorized Jacto outlet, along with all pertinent information, including proof of purchase, model and serial number, total hours of operation, and identified defect.

The replacement of assemblies such as pumps, control valves, engines, transmissions, hydraulic pistons, etc., shall only be performed if the defect cannot be repaired by replacing individual parts and/or components.

### Warranty Exclusions and Limitations

Jacto assumes no responsibility for damages, loss or injury resulting from:

- Normal wear and tear.
- Parts considered as normal wear and tear items, such as, but not limited to: belts, filters, PTO Shafts, hoses, nozzles, batteries, tires, pistons, and pressure gauges.
- Hydraulic, lubricating oils and grease.
- Misuse, neglect, improper maintenance, cleaning or adjustments.
- Modifications to or removal of original component parts.
- Spare or replacement parts not conforming to manufacturer's specifications.
- Service by other than an authorized Jacto servicing outlet.
- Damages of any nature resulting from action of gases or chemicals used in the equipment.

Events beyond our control resulting in delays in performing services do not confer to the owner the right to indemnity or to extension of the warranty period.

This warranty is limited to the terms stated herein. Jacto disclaims all liability for incidental or consequential damages. Some states do not allow the exclusion of incidental or consequential damages, so these limitations may not apply. This warranty gives you specific legal rights and you may have other rights, which vary from state to state.

Jacto reserves the right to change the design or specification of any product without obligation to modify previously produced units.





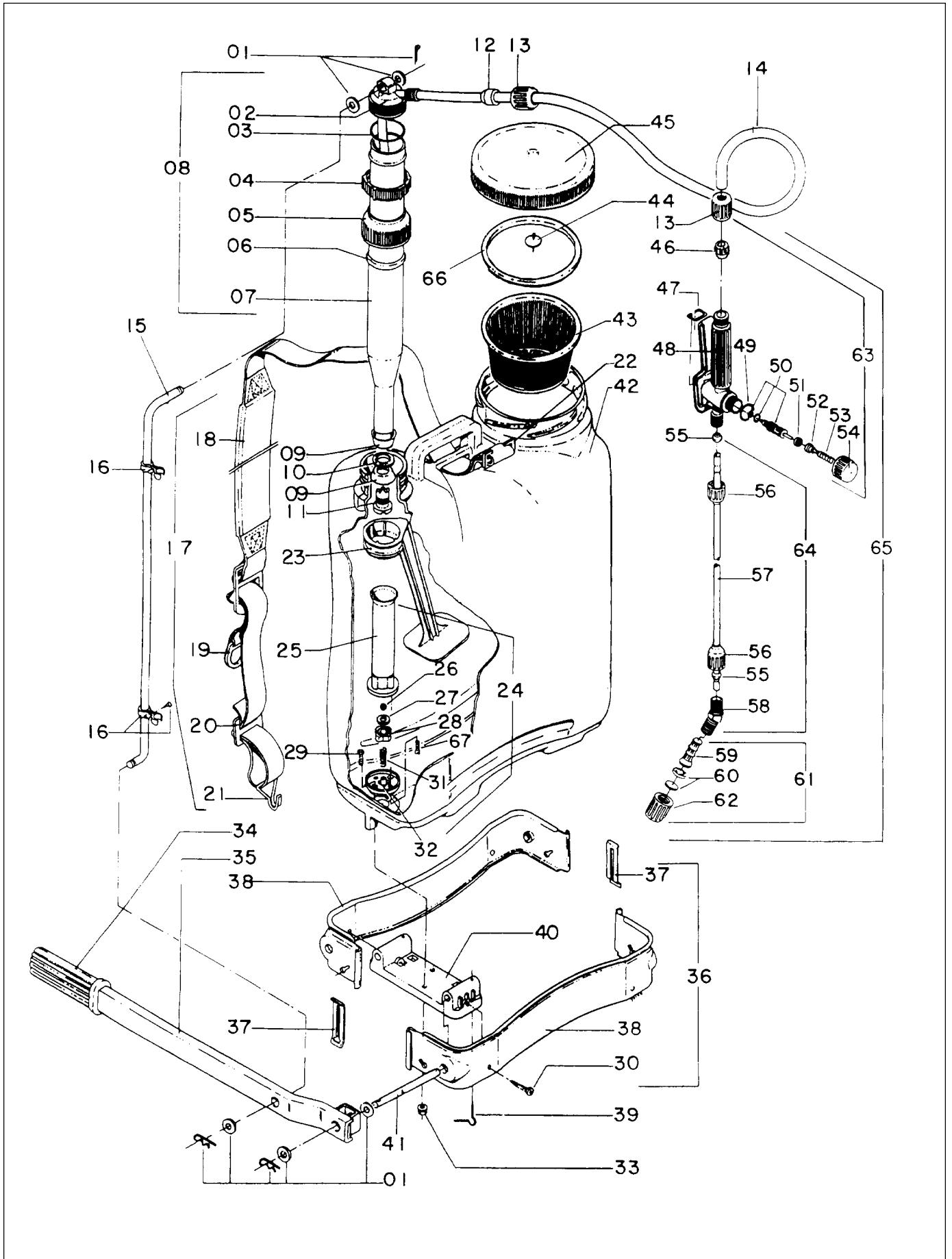

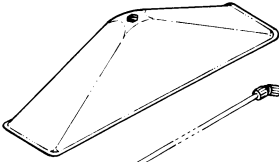
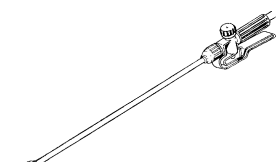
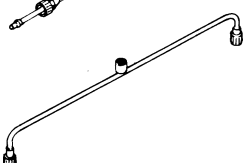
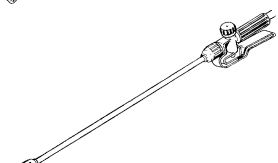
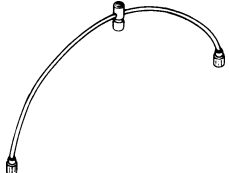
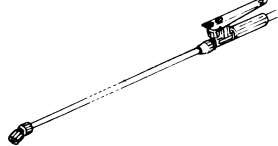
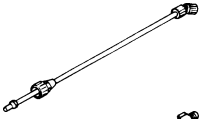

For recording purposes, and so we can notify you regarding product updates, the product registration card must be completed, signed by the original purchaser, and returned to Jacto within 30 days of original purchase date. All product registration cards returned will be entered into a random drawing for a Jacto backpack sprayer.

# JACTO CD400/D550 BACKPACK SPRAYER ILLUSTRATED PARTS LIST

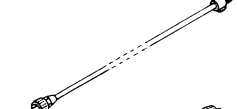



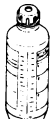
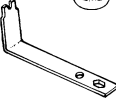

Item	Part No.	Description	Qty.	Item	Part No.	Description	Qty.
	878033	Sprayer CD400	1	34	002683	Handgrip	1
	878157	Sprayer CD550	1	35	661363	Pump lever	1
01	942102	Washers and Cotter pin set	1	36	878140	Split base (Items 37-41)	1
02	942680	Chamber cover	1	37	942896	Base clamp	2
03	573154	O-ring ORI-136	1	38	942888	Half base	2
04	040964	Chamber nut	1	39	433888	Shaft lock	1
05	878074	Packing ring nut	1	40	433870	Base reinforcement	1
06	831230	Packing ring	1	41	433896	Pump lever shaft	1
07	942722	Chamber body	1	42	878041	CD400 Tank with lid (Items 42-45 & 66)	1
08	878199	Chamber assembly (items 2, 3, 4, 7, 9, 10, 11, 12, and 13)	1	42A	878165	CD550 Tank w/lid (Items 42A-45 & 66)	1
09	743880	Plunger	2	43	647123	Strainer	1
10	942763	Plunger spacer	1	44	560573	Lid diaphragm	1
11	402297	Chamber valve	1	45	878132	Lid with diaphragm and seal	1
12	635334	Cone packing	1	46	661330	Hose lock	1
13	942193	Screw cap S-20	2	47	229773	Trigger lock	1
14	635326	Hose 5/16" X 70"	1	48	229757	Trigger valve body	1
15	661397	Pump lever connecting rod	1	49	229781	O-ring ORI-19	1
16	838003	Lance holders set	1	50	229740	Needle and seal	1
17	573006	Shoulder straps assembly (Items 18-22)	1	51	351536	Seal 2.0 X 14.5	1
18	573014	Padded strap & buckle	2	52	433730	Seal base	1
19	229971	Strap with handle	1	53	904284	Compression spring	1
20	502757	Buckle	2	54	229732	Trigger valve cap	1
21	433474	Shoulder strap hook	2	55	909309	Cone packing	2
22	214817	Shoulder strap lock	1	56	915744	Screw cap	2
23	300582	Agitator	1	57	904235	Spray lance tube	1
24	570911	Cylinder assembly (Items 25-33)	1	58	560649	Elbow assembly 11/16	1
25	570929	Cylinder	1	59	730366	Nozzle strainer (40 mesh)	1
26	715474	Ball	1	60	217174	Nozzle JD-12P	1
27	565960	Packing 17X12X3	1	61	427062	Nozzle assembly (Items 59, 60, and 62)	1
28	570945	Ball seat	1	62	229724	Nozzle cap	1
29	351486	Bolt M-6 X 20 X 1.0	2	63	635847	Trigger valve ass'y (Items 13, 46-54)	1
30	211227	Screw 14 X 3/4"	2	64	100131	Lance tube w/elbow (Items 55-58)	1
31	336412	Compression spring	1	65	878371	Spray lance ass'y (Items 61, 63 & 64)	1
32	570937	Cylinder base	1	66	837922	Tank lid seal	1
33	636126	Flanged nut	1	67	336503	Screw 1/4" X 1"	2

## Optional Accessories

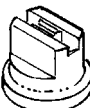
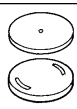
Part Number	Description	Part Number	Description
	<b>558452</b> Spray hood for nonselective herbicides when spraying under windy conditions. For use with deflector-type nozzles. Complete with brass lance and Kematal flat fan nozzle 110-SF-015.		<b>229575</b> Spray lance assembly (21.6"). Plastic handle, trigger valve and spray tube. 40 mesh stainless steel nozzle and trigger valve filters included. Fitted with JD-12P cone nozzle.
	<b>902296</b> Brass spray boom (27.5") for use with agrichemicals and foliar fertilizers applied to row crops. Provides 40" coverage. JD-12P cone nozzles and 40 mesh stainless steel filter included.		<b>878371</b> Spray lance assembly (21.6"). Plastic handle and trigger valve, and brass spray tube. 40 mesh stainless steel nozzle and trigger valve filters included. Fitted with JD-12P cone nozzle.
	<b>907873</b> Flexible annealed copper boom fitted with three JD-12P cone nozzles. For use with agrichemicals and foliar fertilizers on row crops. Can be easily shaped as appropriate to provide proper coverage. 40 mesh stainless steel filter included.		<b>725267</b> All brass spray lance assembly (21.6") for extra duty applications. Trigger valve and spray tube are brass. 40 mesh stainless steel nozzle and trigger valve filters included. Fitted with JD-12P cone nozzle.
	<b>831107</b> Brass extension (11.8") complete with plastic fittings for extra reach. Attachable to original lance.		<b>838169</b> Standard Field Repair Kit for HD400. Includes components to quickly rebuild trigger assembly and the piston cup. <b>Contains:</b> Piston cup, trigger valve needle, nozzle filter, adjustable cone nozzle, and deflector nozzle.
	<b>728139</b> Brass extension (23.6") complete with plastic fittings for extra reach. Attachable to original lance.		<b>761866</b> Standard Field Repair Kit for HD300, CD400, CD550. Includes components to quickly rebuild trigger assembly and the piston cup. <b>Contains:</b> Piston cup, trigger valve needle, nozzle filter, adjustable cone nozzle, and deflector nozzle.
	<b>100016</b> Brass extension (6.3") complete with two JD-12P cone nozzles for doubling output of agrichemicals and foliar fertilizers on perennials. 40 mesh stainless steel filter included.		<b>834382</b> Standard X-15 Field Repair Kit. This Kit includes components to quickly rebuild the trigger assembly and the piston cup. Included are trigger valve needle assembly, trigger valve cap, 2 diaphragms and piston cup 45 x 12.
	<b>834309</b> Flow calibrator bottle. For accurate calibration of backpack sprayers to prevent waste and damage to the environment.		
	<b>452284</b> All purpose metal wrench for general maintenance of Jacto backpack sprayers.		
	<b>565648</b> Plastic anti-drip valve for agrichemicals and foliar fertilizer application. Attaches to lance and compatible with any type of cone or flat fan nozzle.		

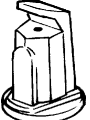
## Jacto Optional Spray Nozzles

Nozzle Type	Part Number	Application	Pressure (psi)	Flow Rate (ml/min)	Flow Rate (gal/min)	
	454215 80EF015 Kematal green	Herbicides	45	610	0.16	
	454223 80EF02 Kematal yellow					
	454231 80EF03 Kematal blue					
	717942 JD-10A Stainless steel	Agrochemicals and foliar fertilizers	45	300	0.08	
	217174 JD-12P Stainless steel					615
	457317 HC-02 Kematal yellow			830	0.22	
	457325 HC-04 Kematal red			1680	0.44	
	457333 HC-05 Kematal brown			2060	0.54	
	457390 DEF-04 Kematal red			15	950	0.25
	457408 DEF-05 Kematal brown			15	1200	0.32
	457416 DEF-06 Kematal gray			15	1540	0.41
	323725 Yellow			45	315	0.08
	015024 Red			45	640	0.17
	325787 Blue	45	710	0.19		

**Note:** All Jacto sprayers come with the JD-12P nozzle installed as standard equipment.



JACTO INC.  
11971 SW Herman Rd  
Tualatin, OR 97062  
1-800-JACTO-10